



CARESOURCE

FOR SCIENTIFIC & LABORATORY EQUIPMENT TR. CO. L.L.C

Email: sales@caresourceglobal.com Mob: +971529418683

Art.Nr.	Beschreibung Description	Size	Spez.
---------	----------------------------	------	-------

243-005-00	GIGLI Drahtsägen-Handgriff wire saws handle mango de gancho		
------------	----------------------------------------------------------------------	--	--



GIGLI (OLIVECRONA)

243-010-30	30,0cm; 11 6/8"
243-010-40	40,0cm; 15 6/8"
243-010-50	50,0cm; 19 5/8"
243-010-60	60,0cm; 23 5/8"
243-010-70	70,0cm; 27 4/8"



243-026-33	DE MARTEL Einführungsinstrument wire saw guide conductor para para sierras de hilo	33,0cm; 13"
------------	---------------------------------------------------------------------------------------------	-------------



Schädelstanzen
Cranial Rongeur
Pinza sacabocados craneales

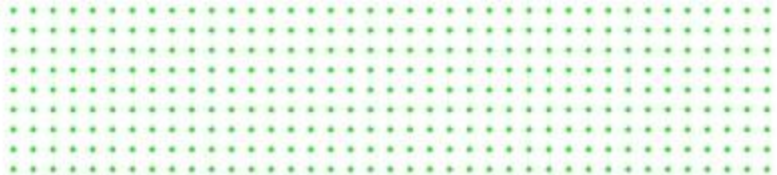

CARESOURCE

FOR SCIENTIFIC & LABORATORY EQUIPMENT TR. CO. L.L.C

Email: sales@caresourceglobal.com Mob: +971529418683

Art.Nr.	Beschreibung Description	Size	Spez.
243-040-00	DE VILBISS	21,0cm; 8 2/8"	



DE VILBISS Ersatzklingen
spare blades only
hoja de repuesto

243-040-01 Fig. 4



243-040-02 Fig. 5



Schädelstanzen
Cranial Rongeur
Pinza sacabocados craneales



CARESOURCE

FOR SCIENTIFIC & LABORATORY EQUIPMENT TR. CO. L.L.C

Email: sales@caresourceglobal.com Mob: +971529418683

Art.Nr.	Beschreibung Description	Size	Spez.
243-044-20	DAHLGREEN	19,5cm; 7 5/8"	



243-044-01	DAHLGREEN Ersatzklinge spare blade hoja de repuesto		
------------	-----------------------------------------------------------	--	--



243-046-22	CONE bis 12 mm up to 12 mm a 12 mm	22,5 cm; 8 7/8"	
------------	-------------------------------------------	-----------------	--



Schädelhalter
Skull traction tongs
Estribos de tracción craneal

CARESOURCE

FOR SCIENTIFIC & LABORATORY EQUIPMENT TR. CO. L.L.C

Email: sales@caresourceglobal.com Mob: +971529418683

Art.Nr.	Beschreibung Description	Size	Spez.
243-050-01	CRUTCHFIELD bis 105 mm up to 105 mm a 105 mm		



243-050-02	CRUTCHFIELD bis 155 mm up to 155 mm a 155 mm		
------------	-----------------------------------------------------	--	--



Vorböhrer
drill point
perforador

7,0cm; 2 6/8"

243-051-35 Ø 3,5 mm 

243-051-50 Ø 5,0 mm 

Schädelhalter
Skull traction tongs
Estribos de tracción craneal



CARESOURCE

FOR SCIENTIFIC & LABORATORY EQUIPMENT TR. CO. L.L.C

Email: sales@caresourceglobal.com Mob: +971529418683

Art.Nr.	Beschreibung Description	Size	Spez.
243-055-00	bis 175 mm up to 175 mm a 175 mm		



243-055-01	Ersatzdorn Spare pin Espina de repuesto
------------	-----------------------------------------------



CARESOURCE

FOR SCIENTIFIC & LABORATORY EQUIPMENT TR. CO. L.L.C

Email: sales@caresourceglobal.com Mob: +971529418683

Art.Nr.	Beschreibung Description	Size	Spez.
---------	----------------------------	------	-------

243-070-00

LEYLA

SET

1-Arm | with 1 arm | con 1 brazo

bestehend aus: | consisting of: | compuesto de:

1x 243-070-10 Spannarm | Flexible arm | Brazo

1x 243-070-20 Fixiervorrichtung | Fixation base | Fijador

1x 243-070-31 Spatelhalter | Support | Porta-espátula



243-071-00

LEYLA

SET

2-Arm | with 2 arms | con 2 brazos

bestehend aus: | consisting of: | compuesto de:

2x 243-070-10 Spannarm | Flexible arm | Brazo

1x 243-070-21 Fixiervorrichtung | Fixation base | Fijador

2x 243-070-31 Spatelhalter | Support | Porta-espátula



Hirnretraktor
Brain retractor
Separador cerebro



CARESOURCE

FOR SCIENTIFIC & LABORATORY EQUIPMENT TR. CO. L.L.C

Email: sales@caresourceglobal.com Mob: +971529418683

Art.Nr.	Beschreibung Description	Size	Spez.
243-075-00	<p>LEYLA 1-Arm with 1 arm con 1 brazo</p> <p>bestehend aus: consisting of: compuesto de: 1 x 243-073-10; 243-073-20; 243-073-31; 243-070-10; 243-070-30</p>		SET

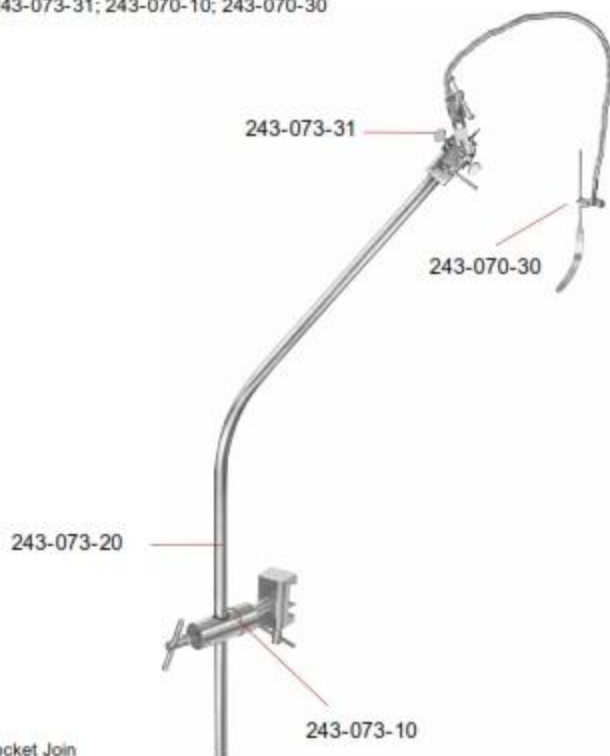

243-073-10	Kugelgelenkkolben Ball and Socket Join zapato p.la f.jacion
243-073-20	Haltearm holding rod brazo
243-073-31	Kupplungskopf Coupling head Acoplamiento
243-070-10	Spannarm Flexible arm Brazo
243-070-30	Spatehalter Support Porta-espátula

CARESOURCE

FOR SCIENTIFIC & LABORATORY EQUIPMENT TR. CO. L.L.C

Email: sales@caresourceglobal.com Mob: +971529418683

Art.Nr.	Beschreibung Description	Size	Spez.
243-077-00	<p>LEYLA 2-Arm with 2 arms con 2 brazos</p> <p>bestehend aus: consisting of: compuesto de: 1 x 243-073-10; 1 x 243-073-20; 2 x 243-073-31; 2 x 243-070-10; 1 x 243-070-30; 1 x 243-070-31</p>		SET

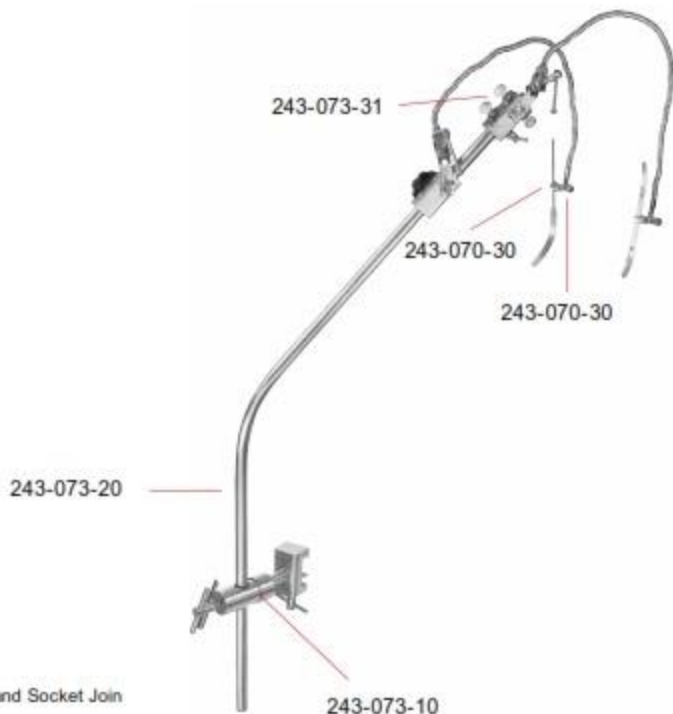

243-073-10	Kugelgelenkkolben Ball and Socket Join zapato p.la f'jacion
243-073-20	Haltearm holding rod brazo
243-073-31	Kupplungskopf Coupling head Acoplamiento
243-070-10	Spannarm Flexible arm Brazo
243-070-30	Spatelhalter Support Porta-espátula
243-070-31	Spatelhalter Support Porta-espátula



CARESOURCE

FOR SCIENTIFIC & LABORATORY EQUIPMENT TR. CO. L.L.C

Email: sales@caresourceglobal.com Mob: +971529418683

Art.Nr.	Beschreibung Description	Size	Spz.
243-070-10	Spannarm flexible arm brazo		
243-070-20	Fixiervorrichtung für 1 Arm zum Festschrauben am Schädel fixation base for 1 arm at skull fijador para 1 brazo al craneo		
243-070-21	Fixiervorrichtung für 2 Arme zum Festschrauben am Schädel fixation base for 2 arms at skull fijador para 2 brazos al craneo		
243-070-22	Fixiervorrichtung für 1 Arm zum Festschrauben am Starrarm fixation base for 1 arm at rigid arm fijador para 1 brazo al brazo rigido		
243-070-30	Halter für Hirnspatel mit rundem Schaft holder for brain spatula with round stem soporte para espátulas con vástago redondo		
243-070-31	Halter für flache Hirnspatel holder for flat brain spatula soporte para espátulas llanas		

CARESOURCE

FOR SCIENTIFIC & LABORATORY EQUIPMENT TR. CO. L.L.C

Email: sales@caresourceglobal.com Mob: +971529418683

Art.Nr.	Beschreibung Description	Size	Spz.
	HEIFETZ	20,0cm; 7 7/8"	
			
243-130-08	8,0 mm		
243-130-11	11,0 mm		
243-130-14	14,0 mm		
243-130-17	17,0 mm		
243-130-20	20,0 mm		
	HEIFETZ	15,5cm; 6 1/8"	
			
243-132-08	8,0 mm		
243-132-11	11,0 mm		
243-132-14	14,0 mm		
243-132-17	17,0 mm		
	OLIVECRONA	18,0cm; 7"	
	konkav concave concáva		
			
243-136-01	7 + 9 mm		
243-136-02	11 + 13 mm		
243-136-03	15 + 18 mm		
243-136-04	19 + 21 mm		



CARESOURCE

FOR SCIENTIFIC & LABORATORY EQUIPMENT TR. CO. L.L.C

Email: sales@caresourceglobal.com Mob: +971529418683

Art.Nr.	Beschreibung Description	Size	Spez.
---------	----------------------------	------	-------

OLIVECRONA

18,0cm; 7"

konvex | convex | convexo



243-138-01	7 + 9 mm
243-138-02	11 + 13 mm
243-138-03	15 + 18 mm
243-138-04	19 + 21 mm

biegsam | malleable | maleable

20,0cm; 7 7/8"



243-146-12	12,0 mm
243-146-17	17,0 mm

243-148-19 CUSHING





19,5cm; 7 5/8"
10 + 12 mm



CARESOURCE

FOR SCIENTIFIC & LABORATORY EQUIPMENT TR. CO. L.L.C

Email: sales@caresourceglobal.com Mob: +971529418683

Art.Nr.	Beschreibung Description	Size	Spez.
243-200-20	HORSLEY	20,0cm; 7 7/8"	
243-202-21	SACHS	21,0cm; 8 2/8"	
243-203-07	HOLSHER	21,0cm; 8 2/8"	
243-205-23	SCOVILLE	23,0cm; 9" 8,0 mm	











Nervwurzelhaken
Nerve root retractors
Separadores para la raíz nervio



CARESOURCE

FOR SCIENTIFIC & LABORATORY EQUIPMENT TR. CO. L.L.C

Email: sales@caresourceglobal.com Mob: +971529418683

Art.Nr.	Beschreibung Description	Size	Spez.
243-207-00	LOVE 	21,5cm; 8 4/8" 	
243-207-45	LOVE 	17,5cm; 6 7/8" 	45°
243-207-90	LOVE 	11,0cm; 4 3/8" 	90°
243-208-22	LOVE 	21,0cm; 8 2/8" 	
243-213-20	SCOVILLE 	20,0cm; 7 7/8" 8,0 mm 	

243

Nervhaken; Durahaken
Nerve hooks; Dura hooks
Ganchos para nervios; Ganchos para duramadre

CARESOURCE

FOR SCIENTIFIC & LABORATORY EQUIPMENT TR. CO. L.L.C

Email: sales@caresourceglobal.com Mob: +971529418683

Art.Nr.	Beschreibung Description	Size	Spez.
243-217-17	SMITHWICK	16,5cm; 6 4/8"	



243-217-21	SMITHWICK	21,0cm; 8 4/8"	
------------	-----------	----------------	--



243-221-14	CUSHING	14,5cm; 5 6/8"	
------------	---------	----------------	--















243



CARESOURCE

FOR SCIENTIFIC & LABORATORY EQUIPMENT TR. CO. L.L.C

Email: sales@caresourceglobal.com Mob: +971529418683

Art.Nr.	Beschreibung Description	Size	Spez.
	SACHS	21,0cm; 8 4/8"	
			
243-228-21			
243-230-21			
243-231-15	FRAZIER	16,5cm; 6 4/8"	
			
	OLIVECRONA		
			
			
243-234-18	18,0cm; 7 1/8"		
243-234-24	24,0cm; 9 4/8"		
	OLIVECRONA		
			
			
243-235-19	19,5cm; 7 5/8"		
243-235-24	24,0cm; 9 4/8"		

CARESOURCE

FOR SCIENTIFIC & LABORATORY EQUIPMENT TR. CO. L.L.C

Email: sales@caresourceglobal.com Mob: +971529418683

Art.Nr.	Beschreibung Description	Size	Spez.
243-236-21	MILLIGAN	21,0cm; 8 4/8"	



243-237-22		22,0cm; 8 5/8"	
------------	--	----------------	--



243-238-01	TOENNIS	24,0cm; 9 4/8"	
------------	---------	----------------	--



243-239-24	DAVIS	24,5cm; 9 5/8"	
------------	-------	----------------	--





CARESOURCE

FOR SCIENTIFIC & LABORATORY EQUIPMENT TR. CO. L.L.C

Email: sales@caresourceglobal.com Mob: +971529418683

Art.Nr.	Beschreibung Description	Size	Spez.
PENFIELD			
243-240-01	Fig. 1 17,5cm; 6 7/8"		
243-240-02	Fig. 2 19,5cm; 7 5/8"		
243-240-03	Fig. 3 19,5cm; 7 5/8"		
243-240-04	Fig. 4 20,5cm; 8 1/8"		
243-240-05	Fig. 5 18,5cm; 7 2/8"		

CARESOURCE

FOR SCIENTIFIC & LABORATORY EQUIPMENT TR. CO. L.L.C

Email: sales@caresourceglobal.com Mob: +971529418683

Art.Nr. Beschreibung | Description Size Spz.

CASPAR

SET



243-350-00 Wundspreizer, bestehend aus:
243-350-01 1 Rahmen
243-350-10 1 Drehschlüssel
243-351-38 1 Haken 38 mm
243-352-37 1 Seitenvalven 37 x 22 mm
243-352-43 1 Seitenvalven 43 x 22 mm
243-352-47 1 Seitenvalven 47 x 22 mm
243-352-52 1 Seitenvalven 52 x 22 mm
243-352-57 1 Seitenvalven 57 x 22 mm

243-350-00 Separadores, compuesto de:
243-350-01 1 cuadro
243-350-10 1 llave
243-351-38 1 ganchos 38 mm
243-352-37 1 valvas laterales 37 x 22 mm
243-352-43 1 valvas laterales 43 x 22 mm
243-352-47 1 valvas laterales 47 x 22 mm
243-352-52 1 valvas laterales 52 x 22 mm
243-352-57 1 valvas laterales 57 x 22 mm

243-350-00 Wound Spreaders, consisting of:
243-350-01 1 frame
243-350-10 1 key
243-351-38 1 hooks 38 mm
243-352-37 1 lateral blades 37 x 22 mm
243-352-43 1 lateral blades 43 x 22 mm
243-352-47 1 lateral blades 47 x 22 mm
243-352-52 1 lateral blades 52 x 22 mm
243-352-57 1 lateral blades 57 x 22 mm

243

Laminektomie-Wundspreizer
Laminectomy Rongeurs
Separadores para laminectomía



CARESOURCE

FOR SCIENTIFIC & LABORATORY EQUIPMENT TR. CO. L.L.C

Email: sales@caresourceglobal.com Mob: +971529418683

Art.Nr.	Beschreibung Description	Size	Spez.
243-350-10	Drehschlüssel key llave		

CASPAR Haken
hooks
ganchos

243-351-38 38,0 mm



243-351-58 58,0 mm





243

CARESOURCE

FOR SCIENTIFIC & LABORATORY EQUIPMENT TR. CO. L.L.C

Email: sales@caresourceglobal.com Mob: +971529418683

Art.Nr.	Beschreibung Description	Size	Spz.
CASPAR			
243-352-32	32 x 22 mm		
243-352-37	37 x 22 mm		
243-352-43	43 x 22 mm		
243-352-47	47 x 22 mm		
243-352-52	52 x 22 mm		
243-352-57	57 x 22 mm		
243-352-62	62 x 22 mm		
243-352-67	67 x 22 mm		
			
CASPAR			
243-353-32	32 x 37 mm		
243-353-37	37 x 37 mm		
243-353-43	43 x 37 mm		
243-353-47	47 x 37 mm		
243-353-52	52 x 37 mm		
243-353-62	62 x 37 mm		
243-353-67	67 x 37 mm		
			
CASPAR			
243-354-32	32 x 52 mm		
243-354-37	37 x 52 mm		
243-354-43	43 x 52 mm		
243-354-47	47 x 52 mm		
243-354-52	52 x 52 mm		
243-354-62	62 x 52 mm		
243-354-67	67 x 52 mm		
			



CARESOURCE

FOR SCIENTIFIC & LABORATORY EQUIPMENT TR. CO. L.L.C

Email: sales@caresourceglobal.com

Mob: +971529418683

Art.Nr. Beschreibung | Description Size Spz.

CASPAR

SET



243-360-00	Wundspreizer, bestehend aus:
243-360-01	1 Rahmen
243-361-40	1 Valve medial 40 x 23 mm
243-361-45	1 Valve medial 45 x 23 mm
243-361-50	1 Valve medial 50 x 23 mm
243-361-55	1 Valve medial 55 x 23 mm
243-361-60	1 Valve medial 60 x 23 mm
243-363-40	1 Valve lateral 40 x 23 mm
243-363-45	1 Valve lateral 45 x 23 mm
243-363-50	1 Valve lateral 50 x 23 mm
243-363-55	1 Valve lateral 55 x 23 mm
243-363-60	1 Valve lateral 60 x 23 mm

243-360-00	Separadores, compuesto de:
243-360-01	1 cuadro
243-361-40	1 valva medial 40 x 23 mm
243-361-45	1 valva medial 45 x 23 mm
243-361-50	1 valva medial 50 x 23 mm
243-361-55	1 valva medial 55 x 23 mm
243-361-60	1 valva medial 60 x 23 mm
243-363-40	1 valva lateral 40 x 23 mm
243-363-45	1 valva lateral 45 x 23 mm
243-363-50	1 valva lateral 50 x 23 mm
243-363-55	1 valva lateral 55 x 23 mm
243-363-60	1 valva lateral 60 x 23 mm

243-360-00	Wound Spreaders, consisting of:
243-360-01	1 frame
243-361-40	1 valve medial 40 x 23 mm
243-361-45	1 valve medial 45 x 23 mm
243-361-50	1 valve medial 50 x 23 mm
243-361-55	1 valve medial 55 x 23 mm
243-361-60	1 valve medial 60 x 23 mm
243-363-40	1 valve lateral 40 x 23 mm
243-363-45	1 valve lateral 45 x 23 mm
243-363-50	1 valve lateral 50 x 23 mm
243-363-55	1 valve lateral 55 x 23 mm
243-363-60	1 valve lateral 60 x 23 mm

CARESOURCE

FOR SCIENTIFIC & LABORATORY EQUIPMENT TR. CO. L.L.C

Email: sales@caresourceglobal.com Mob: +971529418683

Art.Nr.	Beschreibung Description	Size	Spz.
	CASPAR medial medial medial		
243-361-40	40 x 23 mm		
243-361-45	45 x 23 mm		
243-361-50	50 x 23 mm		
243-361-55	55 x 23 mm		
243-361-60	60 x 23 mm		
	CASPAR lateral lateral lateral		
243-363-40	40 x 23 mm		
243-363-45	45 x 23 mm		
243-363-50	50 x 23 mm		
243-363-55	55 x 23 mm		
243-363-60	60 x 23 mm		
	CASPAR stumpf blunt roma		
243-365-40	40 x 23 mm		
243-365-45	45 x 23 mm		
243-365-50	50 x 23 mm		
243-365-55	55 x 23 mm		
243-365-60	60 x 23 mm		
243-365-65	65 x 23 mm		
	CASPAR stumpf blunt roma		
243-367-50	50 x 25 mm		
243-367-60	60 x 25 mm		



CARESOURCE

FOR SCIENTIFIC & LABORATORY EQUIPMENT TR. CO. L.L.C

Email: sales@caresourceglobal.com Mob: +971529418683

Art.Nr.	Beschreibung Description	Size	Spz.
243-368-12	Pinzette zum Valvenwechseln forceps for changing blades pinza para cambiar las valvas	11,5cm; 4 1/2"	



CASPAR

SET



243-370-00
243-370-01
243-365-45
243-365-50
243-365-55
243-365-60
243-365-65

bestehend aus:
1 Sperrer
1 Valve stumpf 45 x 23 mm
1 Valve stumpf 50 x 23 mm
1 Valve stumpf 55 x 23 mm
1 Valve stumpf 60 x 23 mm
1 Valve stumpf 65 x 23 mm

243-370-00
243-370-01
243-365-45
243-365-50
243-365-55
243-365-60
243-365-65

compuesto de:
1 separador
1 valva romo 45 x 23 mm
1 valva romo 50 x 23 mm
1 valva romo 55 x 23 mm
1 valva romo 60 x 23 mm
1 valva romo 65 x 23 mm

243-370-00
243-370-01
243-365-45
243-365-50
243-365-55
243-365-60
243-365-65

consisting of:
1 spreader
1 valve blunt 45 x 23 mm
1 valve blunt 50 x 23 mm
1 valve blunt 55 x 23 mm
1 valve blunt 60 x 23 mm
1 valve blunt 65 x 23 mm

CARESOURCE

FOR SCIENTIFIC & LABORATORY EQUIPMENT TR. CO. L.L.C

Email: sales@caresourceglobal.com Mob: +971529418683

Art.Nr.	Beschreibung Description	Size	Spz.
---------	----------------------------	------	------

CASPAR

SET



243-380-00	bestehend aus:
243-380-01	1 Sperrer
243-365-45	1 Valve stumpf 45 x 23 mm
243-365-50	1 Valve stumpf 50 x 23 mm
243-365-55	1 Valve stumpf 55 x 23 mm
243-365-60	1 Valve stumpf 60 x 23 mm
243-365-65	1 Valve stumpf 65 x 23 mm

243-380-00	compuesto de:
243-380-01	1 separador
243-365-45	1 valva romo 45 x 23 mm
243-365-50	1 valva romo 50 x 23 mm
243-365-55	1 valva romo 55 x 23 mm
243-365-60	1 valva romo 60 x 23 mm
243-365-65	1 valva romo 65 x 23 mm

243-370-00	consisting of:
243-370-01	1 spreader
243-365-45	1 valve blunt 45 x 23 mm
243-365-50	1 valve blunt 50 x 23 mm
243-365-55	1 valve blunt 55 x 23 mm
243-365-60	1 valve blunt 60 x 23 mm
243-365-65	1 valve blunt 65 x 23 mm

Lumbalwundspreizer
Lumbal Retractors
Separadores lumbales autoestáticos



CARESOURCE

FOR SCIENTIFIC & LABORATORY EQUIPMENT TR. CO. L.L.C

Email: sales@caresourceglobal.com Mob: +971529418683

Art.Nr.	Beschreibung Description	Size	SpHz.
---------	----------------------------	------	-------

CASPAR



243-390-40	40,0 mm
243-390-45	45,0 mm
243-390-50	50,0 mm
243-390-55	55,0 mm
243-390-60	60,0 mm

243

CARESOURCE

FOR SCIENTIFIC & LABORATORY EQUIPMENT TR. CO. L.L.C

Email: sales@caresourceglobal.com Mob: +971529418683

Art.Nr. Beschreibung | Description Size Spz.

CASPAR

SET



243-410-00 bestehend aus:
243-410-01 1 Rahmen
243-413-35 1 Seitenvalve 35 x 12 mm
243-413-40 1 Seitenvalve 40 x 13 mm
243-413-45 1 Seitenvalve 45 x 13 mm
243-413-50 1 Seitenvalve 50 x 14 mm
243-413-55 1 Seitenvalve 55 x 14 mm
243-413-60 1 Seitenvalve 60 x 15 mm

243-410-00 Separadores, compuesto de:
243-410-01 1 cuadro
243-413-35 1 valvas laterales 35 x 12 mm
243-413-40 1 valvas laterales 40 x 13 mm
243-413-45 1 valvas laterales 45 x 13 mm
243-413-50 1 valvas laterales 50 x 14 mm
243-413-55 1 valvas laterales 55 x 14 mm
243-413-60 1 valvas laterales 60 x 15 mm

243-410-00 consisting of:
243-410-01 1 frame
243-413-35 1 lateral blades 35 x 12 mm
243-413-40 1 lateral blades 40 x 13 mm
243-413-45 1 lateral blades 45 x 13 mm
243-413-50 1 lateral blades 50 x 14 mm
243-413-55 1 lateral blades 55 x 14 mm
243-413-60 1 lateral blades 60 x 15 mm



CARESOURCE

FOR SCIENTIFIC & LABORATORY EQUIPMENT TR. CO. L.L.C

Email: sales@caresourceglobal.com Mob: +971529418683

Art.Nr.	Beschreibung Description	Size	SpHz.
	CASPAR lateral lateral lateral		

243-413-35	35 x 12 mm
243-413-40	40 x 13 mm
243-413-45	45 x 13 mm
243-413-50	50 x 14 mm
243-413-55	55 x 14mm
243-413-60	60 x 15mm



CASPAR medial medial medial

243-414-35	35 x 12 mm
243-414-40	40 x 13 mm
243-414-45	45 x 13 mm
243-414-50	50 x 14 mm
243-414-55	55 x 14mm
243-414-60	60 x 15mm



CARESOURCE

FOR SCIENTIFIC & LABORATORY EQUIPMENT TR. CO. L.L.C

Email: sales@caresourceglobal.com Mob: +971529418683

Art.Nr. Beschreibung | Description Size Spz.

SCOVILLE

SET



243-415-00 Wundspreizer, bestehend aus:
243-415-01 1 Rahmen
243-421-50 1 Haken 50 mm
243-423-01 1 Seitenvalven 63 x 25 mm

243-415-00 Separadores, compuesto de:
243-415-01 1 cuadro
243-421-50 1 ganchos 50 mm
243-423-01 1 valvas laterales 63 x 25 mm

243-350-00 Wound Spreaders, consisting of:
243-415-01 1 frame
243-421-50 1 hooks 50 mm
243-423-01 1 lateral blades 63 x 25 mm



CARESOURCE

FOR SCIENTIFIC & LABORATORY EQUIPMENT TR. CO. L.L.C

Email: sales@caresourceglobal.com Mob: +971529418683

Art.Nr. Beschreibung | Description Size Spz.

SCOVILLE-HAVERFIELD mit Gelenkarmen
with articulated arms
con brazos articulados

SET



243-420-00 Wundspreizer, bestehend aus:
243-420-01 1 Rahmen
243-421-50 1 Haken 50 mm
243-423-01 1 Seitenvalven 63 x 25 mm

243-420-00 Separadores, compuesto de:
243-420-01 1 cuadro
243-421-50 1 ganchos 50 mm
243-423-01 1 valvas laterales 63 x 25 mm

243-350-00 Wound Spreaders, consisting of:
243-420-01 1 frame
243-421-50 1 hooks 50 mm
243-423-01 1 lateral blades 63 x 25 mm

SCOVILLE

243-421-50 50,0 mm

243-421-75 75,0 mm



SCOVILLE

243-422-50 50,0 mm

243-422-75 75,0 mm



CARESOURCE

FOR SCIENTIFIC & LABORATORY EQUIPMENT TR. CO. L.L.C

Email: sales@caresourceglobal.com Mob: +971529418683

Art.Nr.	Beschreibung Description	Size	Spz.
	SCOVILLE		
243-423-01	63 x 25 mm		
243-423-02	63 x 51 mm		
243-423-03	67 x 32 mm		
	TAYLOR		
243-425-03	47 x 37 mm		
243-425-04	63 x 51 mm		
243-427-01	48 x 50 mm		
243-427-03	64 x 63 mm		
243-427-04	80 x 57 mm		
243-450-00	BADGLEY	52 x 44 mm	
			



CARESOURCE

FOR SCIENTIFIC & LABORATORY EQUIPMENT TR. CO. L.L.C

Email: sales@caresourceglobal.com Mob: +971529418683

Art.Nr.	Beschreibung Description	Size	Spz.
	CLOWARD	25,0cm; 10"	SET



- 243-460-00 Wundspreizer bestehend aus:
- 243-460-01 1 Sperrer
 - 243-461-40 1 gezahnte Seitenvalve 40 x 15 - 23 mm
 - 243-461-45 1 gezahnte Seitenvalve 45 x 15 - 23 mm
 - 243-461-50 1 gezahnte Seitenvalve 50 x 15 - 23 mm
 - 243-461-55 1 gezahnte Seitenvalve 55 x 15 - 23 mm
 - 243-461-60 1 gezahnte Seitenvalve 60 x 15 - 23 mm

- 243-460-00 Separador, compuesto de:
- 243-460-01 1 separador
 - 243-461-40 1 valva lateral, dentada, 40 x 15 - 23 mm
 - 243-461-45 1 valva lateral, dentada, 45 x 15 - 23 mm
 - 243-461-50 1 valva lateral, dentada, 50 x 15 - 23 mm
 - 243-461-55 1 valva lateral, dentada, 55 x 15 - 23 mm
 - 243-461-60 1 valva lateral, dentada, 60 x 15 - 23 mm

- 243-460-00 self-retaining retractor, consisting of:
- 243-460-01 1 spreader
 - 243-461-40 1 lateral valve, serrated, 40 x 15 - 23 mm
 - 243-461-45 1 lateral valve, serrated, 45 x 15 - 23 mm
 - 243-461-50 1 lateral valve, serrated, 50 x 15 - 23 mm
 - 243-461-55 1 lateral valve, serrated, 55 x 15 - 23 mm
 - 243-461-60 1 lateral valve, serrated, 60 x 15 - 23 mm



CARESOURCE

FOR SCIENTIFIC & LABORATORY EQUIPMENT TR. CO. L.L.C

Email: sales@caresourceglobal.com Mob: +971529418683

Art.Nr.	Beschreibung Description	Size	Spz.
---------	----------------------------	------	------

CLOWARD

13,0cm; 5 1/8"

SET



243-465-00	Wundspreizer, bestehend aus:
243-465-01	1 Sperrer
243-462-40	1 stumpfe Seitenvalve 40 x 15 - 23 mm
243-462-45	1 stumpfe Seitenvalve 45 x 15 - 23 mm
243-462-50	1 stumpfe Seitenvalve 50 x 15 - 23 mm
243-462-55	1 stumpfe Seitenvalve 55 x 15 - 23 mm
243-462-60	1 stumpfe Seitenvalve 60 x 15 - 23 mm

243-465-00	Separador, compuesto de:
243-465-01	1 separador
243-462-40	1 valva lateral, roma, 40 x 15 - 23 mm
243-462-45	1 valva lateral, roma, 45 x 15 - 23 mm
243-462-50	1 valva lateral, roma, 50 x 15 - 23 mm
243-462-55	1 valva lateral, roma, 55 x 15 - 23 mm
243-462-60	1 valva lateral, roma, 60 x 15 - 23 mm

243-465-00	Self-retaining retractor, consisting of:
243-465-01	1 spreader
243-462-40	1 lateral valve, blunt, 40 x 15 - 23 mm
243-462-45	1 lateral valve, blunt, 45 x 15 - 23 mm
243-462-50	1 lateral valve, blunt, 50 x 15 - 23 mm
243-462-55	1 lateral valve, blunt, 55 x 15 - 23 mm
243-462-60	1 lateral valve, blunt, 60 x 15 - 23 mm

243-462-40		40 x 15 - 23 mm	243-462-55	55 x 15 - 23 mm
------------	-------------------------------------------------------------------------------------	-----------------	------------	-----------------

243-462-45		45 x 15 - 23 mm	243-462-60	60 x 15 - 23 mm
------------	-------------------------------------------------------------------------------------	-----------------	------------	-----------------

243-462-50		50 x 15 - 23 mm
------------	-------------------------------------------------------------------------------------	-----------------



CARESOURCE

FOR SCIENTIFIC & LABORATORY EQUIPMENT TR. CO. L.L.C

Email: sales@caresourceglobal.com Mob: +971529418683

Art.Nr.	Beschreibung Description	Size	Spz.
243-473-13	CLOWARD Spreizweite 18 mm spreading 18 mm extensión 18 mm	13,0cm; 5 1/8"	
			
243-482-16	CLOWARD Spreizweite 18 mm spreading 18 mm extensión 18 mm	16,0cm; 6 2/8"	
			
243-497-17	INGE Spreizweite 35 mm spreading 35 mm extensión 35 mm	16,0cm; 6 2/8"	
			
243-498-27	INGE Spreizweite 70 mm spreading 70 mm extensión 70 mm	25,5cm; 10"	
			

Mikro-Pinzetten; Tumorfaßpinzetten
 Micro forceps; Tumor grasping forceps
 Micro Pinzas; Pinzas para agarrar tumores

CARESOURCE

FOR SCIENTIFIC & LABORATORY EQUIPMENT TR. CO. L.L.C

Email: sales@caresourceglobal.com Mob: +971529418683

Art.Nr.	Beschreibung Description	Size	Spz.
---------	----------------------------	------	------

YASARGIL



243-510-18	0,6mm	18,0cm; 7 1/8"
243-510-20	0,6mm	20,0cm; 7 7/8"
243-510-22	0,6mm	22,0cm; 8 5/8"
243-510-24	0,6mm	24,0cm; 9 4/8"
243-512-18	0,9mm	18,0cm; 7 1/8"
243-512-20	0,9mm	20,0cm; 7 7/8"
243-512-22	0,9mm	22,0cm; 8 5/8"
243-512-24	0,9mm	24,0cm; 9 4/8"
243-515-18	 1x2	18,0cm; 7 1/8"



YASARGIL

22,0cm; 8 5/8"

243-520-03	Ø 3,0mm
243-520-05	Ø 5,0mm



YASARGIL-SAMII

24,0cm; 9 4/8"

243-522-03	Ø 3,0mm
243-522-05	Ø 5,0mm
243-522-07	Ø 7,0mm

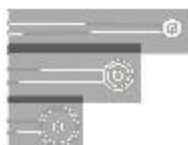

Tumorfaßpinzetten
Tumor grasping forceps
Pinzas para agarrar tumores



CARESOURCE

FOR SCIENTIFIC & LABORATORY EQUIPMENT TR. CO. L.L.C

Email: sales@caresourceglobal.com Mob: +971529418683

Art.Nr.	Beschreibung Description	Size	Spz.
---------	----------------------------	------	------



	YASARGIL	22,0cm; 8 5/8"	
--	-----------------	-----------------------	--

243-524-03	Ø 3,0mm		
------------	---------	--	--

243-524-05	Ø 5,0mm		
------------	---------	--	--

	YASARGIL-SAMII	22,0cm; 8 5/8"	
--	-----------------------	-----------------------	--

243-526-03	Ø 3,0mm		
------------	---------	--	--

243-526-05	Ø 5,0mm		
------------	---------	--	--

	SAMII	23,0cm; 9"	
--	--------------	-------------------	--



243-527-03	Ø 3,0mm		
------------	---------	--	--

243-527-04	Ø 4,0mm		
------------	---------	--	--

243-527-05	Ø 5,0mm		
------------	---------	--	--

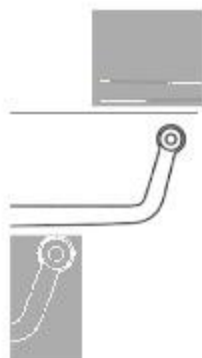

243-529-03	Ø 3,0mm		
------------	---------	--	--

243-529-04	Ø 4,0mm		
------------	---------	--	--

243-529-05	Ø 5,0mm		
------------	---------	--	--

243

Mikro-Knüpfpinzetten
 Micro suture tying forceps
 Micro Pinza para enlazar

CARESOURCE

FOR SCIENTIFIC & LABORATORY EQUIPMENT TR. CO. L.L.C

Email: sales@caresourceglobal.com Mob: +971529418683

Art.Nr.	Beschreibung Description	Size	Spz.
---------	----------------------------	------	------

18,5cm; 7 2/8"



243-516-03	0,3mm
243-516-06	0,6mm
243-517-06	0,6mm



243-550-12	0,3mm	12,0cm; 4 6/8"
243-550-15	0,3mm	15,0cm; 5 7/8"
243-550-18	0,3mm	18,0cm; 7 1/8"
243-550-21	0,3mm	21,0cm; 8 2/8"



243-551-12	0,3mm	12,0cm; 4 6/8"
243-551-15	0,3mm	15,0cm; 5 7/8"
243-551-18	0,3mm	18,0cm; 7 1/8"
243-551-21	0,3mm	21,0cm; 8 2/8"



243-560-12	0,3mm	12,0cm; 4 6/8"
243-560-15	0,3mm	15,0cm; 5 7/8"
243-560-18	0,3mm	18,0cm; 7 1/8"



 1x2

243-561-12	0,3mm	12,0cm; 4,8"
243-561-15	0,3mm	15,0cm; 5 7/8"
243-561-18	0,3mm	18,0cm; 7 1/8"

 1x2

Mikro-Knüpfpinzetten
Micro suture tying forceps
Micro Pinza para enlazar



CARESOURCE

FOR SCIENTIFIC & LABORATORY EQUIPMENT TR. CO. L.L.C

Email: sales@caresourceglobal.com Mob: +971529418683

Art.Nr.	Beschreibung Description	Size	Spz.
243-570-23		23,0cm; 9" 0,6mm	



AUSTIN



243-572-14 0,8mm 14,0cm; 5 4/8"

243-572-18 0,8mm 18,0cm; 7 1/8"

243-574-12 12,0cm; 4 6/8"
0,3mm



243-576-13 VISE 13,5cm; 5 3/8"
0,3mm



243

Mikro-Knüpfpinzetten
Micro suture tying forceps
Micro Pinza para enlazar

CARESOURCE

FOR SCIENTIFIC & LABORATORY EQUIPMENT TR. CO. L.L.C

Email: sales@caresourceglobal.com Mob: +971529418683

Art.Nr.	Beschreibung Description	Size	SpHz.
243-577-13	VISE	13,5cm; 5 3/8 0,3mm	



LAZAR

15,5cm; 6 1/8"



243-578-05 0,5mm

243-578-08 0,8mm

243-580-18

18,5cm; 7 2/8"
0,5mm





CARESOURCE

FOR SCIENTIFIC & LABORATORY EQUIPMENT TR. CO. L.L.C

Email: sales@caresourceglobal.com Mob: +971529418683

Art.Nr.	Beschreibung Description	Size	Spz.
		23,0cm; 9"	



243-620-01 halbscharf | semi-sharp | agudo



243-620-02 stumpf | blunt | romo



243-621-01



243-621-02



243-622-01



243-622-02



243-623-01



243-623-02



23,0cm; 9"



Dissektor | Dissector | Disecador

243-635-01



243-635-02



Raspatorium | Periosteal elevator | Legra

243-635-03



243

CARESOURCE

FOR SCIENTIFIC & LABORATORY EQUIPMENT TR. CO. L.L.C

Email: sales@caresourceglobal.com Mob: +971529418683

Art.Nr.	Beschreibung Description	Size	Spz.
	CASPAR Explorationshaken; isoliert exploration hook; insulated ganchos para exploración; aislados	25,0cm; 10"	



243-644-01 Fig. 1 

243-644-02 Fig. 2 

243-644-03 Fig. 3 

243-644-04 Fig. 4 



CARESOURCE

FOR SCIENTIFIC & LABORATORY EQUIPMENT TR. CO. L.L.C

Email: sales@caresourceglobal.com

Mob: +971529418683

Art.Nr.	Beschreibung Description	Size	SpHz.
	YASARGIL	18,5cm; 7 2/8"	



243-660-01 1,0 mm 

243-660-02 2,5 mm 

243-660-03 Ø 4,0 mm 

















243-660-04 2,5 mm 

243-660-05 3,0 mm 

CARESOURCE

FOR SCIENTIFIC & LABORATORY EQUIPMENT TR. CO. L.L.C

Email: sales@caresourceglobal.com Mob: +971529418683

Art.Nr.	Beschreibung Description	Size	Spz.
	YASARGIL	18,5cm; 7 2/8"	
			
243-661-01		243-661-03	
243-661-02			
243-663-19	YASARGIL	18,5cm; 7 2/8"	
			
	KOOS	18,5cm; 7 2/8"	
			
243-665-01		243-665-02	
243-667-01		243-667-02	
243-669-01		243-669-02	
	YASARGIL	18,5cm; 7 2/8"	
			
243-673-01		243-673-02	



CARESOURCE

FOR SCIENTIFIC & LABORATORY EQUIPMENT TR. CO. L.L.C

Email: sales@caresourceglobal.com

Mob: +971529418683

Art.Nr.	Beschreibung Description	Size	Spz.
	JACOBSON	18,5cm; 7 2/8"	



243-676-19



243-677-02



243-677-01



243-679-18



YASARGIL Fadenführer; geknüpft
 ligature guide and carrier; pointed
 guía-ligadura; abotonada

18,5cm; 7 2/8"



243-685-01

Fig. 1



243-685-03

Fig. 3



243-685-02

Fig. 2



243-685-04

Fig. 4



243-687-19

Gewebekralle
 Tissue claw
 Garra para el tejido

18,5cm; 7 2/8"
 Ø 1,5 mm



CARESOURCE

FOR SCIENTIFIC & LABORATORY EQUIPMENT TR. CO. L.L.C

Email: sales@caresourceglobal.com Mob: +971529418683

Art.Nr.	Beschreibung Description	Size	SpHz.
243-730-22	YASARGIL	19,0cm; 7 4/8"	



Ø 2,2 mm

CASPAR

25,0cm; 9 7/8"



243-800-04

4,0 mm



243-800-05

5,0 mm



CASPAR



243-801-03

3,0 mm



243-801-04

4,0 mm





CARESOURCE

FOR SCIENTIFIC & LABORATORY EQUIPMENT TR. CO. L.L.C

Email: sales@caresourceglobal.com

Mob: +971529418683

Art.Nr.	Beschreibung Description	Size	Spz.
	RAY	18,5cm; 7 2/8"	



243-810-04 Ø 4,0 mm
45°

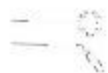

243-812-04 Ø 4,0 mm
90°



243-813-04 Ø 4,0 mm
45°



HARDY

18,5cm; 7 2/8"



243-818-04 Ø 4,0 mm
90°

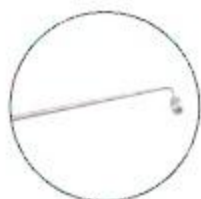

243-818-06 Ø 6,0 mm
90°



CARESOURCE

FOR SCIENTIFIC & LABORATORY EQUIPMENT TR. CO. L.L.C

Email: sales@caresourceglobal.com Mob: +971529418683

Art.Nr.	Beschreibung Description	Size	SpHz.
		24,5cm; 9 5/8"	



HARDY

243-830-01 stumpf | blunt | romo



243-830-02 stumpf | blunt | romo



243-832-01 scharf | sharp | agudo



243-832-02 scharf | sharp | agudo



HARDY-FAHLBUSCH

243-840-01 scharf | sharp | agudo



243-840-02 scharf | sharp | agudo



243-836-24 HARDY







243



CARESOURCE

FOR SCIENTIFIC & LABORATORY EQUIPMENT TR. CO. L.L.C

Email: sales@caresourceglobal.com Mob: +971529418683

Art.Nr.	Beschreibung Description	Size	Spz.
	MC KENZIE Klammeranlegezange clip applying forceps pinza para poner grapas		
			
244-161-15	15,0cm; 5 7/8"		
244-161-19	19,0cm; 7 4/8"		
	OLIVECRONA-TOENNIS Klammeranlegezange clip applying forceps pinza para poner grapas	14,0cm; 5 4/8"	
			
	RANEY Anlege- und Abnehmzange applying/removal forceps pinza para aplicar y quitar agrafes	15,5cm; 6"	
			

Galea Haken
Galea hooks
Galea ganchos

CARESOURCE

FOR SCIENTIFIC & LABORATORY EQUIPMENT TR. CO. L.L.C

Email: sales@caresourceglobal.com Mob: +971529418683

Art.Nr.	Beschreibung Description	Size	Spz.
	YASARGIL		
			
244-185-31	7,0 mm	30,0cm; 11 6/8"	
244-185-41	9,0 mm	41,0cm; 16 1/8"	

CARESOURCE

FOR SCIENTIFIC & LABORATORY EQUIPMENT TR. CO. L.L.C

Email: sales@caresourceglobal.com Mob: +971529418683

Art.Nr. Beschreibung | Description Size Spz.

YASARGIL



	Maul starr rigid jaw boca rigida
	18,0cm; 7"
MINI	244-610-18
STANDARD	244-600-18

YASARGIL



	Maul starr rigid jaw boca rigida		
	17,0cm; 6 3/4"	21,0cm; 8 1/4"	23,0cm; 9"
MINI	244-611-17	244-611-21	244-611-23
STANDARD	244-601-17	244-601-21	244-601-23

	Maul drehbar rotatable jaw boca con acogida giratoria	
	21,0cm; 8 1/4"	23,0cm; 9"
MINI	244-613-21	244-613-23
STANDARD	244-603-21	244-603-23

2/1

Anlegezangen für Gefäßclips
 Applying forceps for vessel clips
 Pinzas para aplicar clips vasculares



CARESOURCE

FOR SCIENTIFIC & LABORATORY EQUIPMENT TR. CO. L.L.C

Email: sales@caresourceglobal.com Mob: +971529418683

Art.Nr. Beschreibung | Description Size Spz.

YASARGIL



Maul drehbar | rotatable jaw
 boca con acogida giratoria

	Maul drehbar rotatable jaw boca con acogida giratoria		
	7,0cm; 2 3/4"	9,0cm; 3 1/2"	11,0cm; 4 1/3"
MINI	244-677-07	244-677-09	244-677-11
	244-677-07T Ti	244-677-09T Ti	244-677-11T Ti
STANDARD	244-637-07	244-637-09	244-637-11
	244-637-07T Ti	244-637-09T Ti	244-637-11T Ti

244

Anlegezangen für Gefäßclips; Schaft drehbar
 Applying forceps for vessel clips; shaft rotatable
 Pinzas para aplicar clips vasculares; vástago girato

CARESOURCE

FOR SCIENTIFIC & LABORATORY EQUIPMENT TR. CO. L.L.C

Email: sales@caresourceglobal.com Mob: +971529418683

Art.Nr. Beschreibung | Description Size Spz.

YASARGIL



Maul starr rigid jaw boca rígida							
7,0cm; 2 3/4"		9,0cm; 3 1/2"		11,0cm; 4 1/3"		13,0cm; 5 1/8"	
MINI	244-680-07	244-680-09	244-680-11	244-680-13			
	244-680-07T Ti	244-680-09T Ti	244-680-11T Ti	244-680-13T Ti			
STANDARD	244-640-07	244-640-09	244-640-11	244-640-13			
	244-640-07T Ti	244-640-09T Ti	244-640-11T Ti	244-640-13T Ti			

Maul drehbar rotatable jaw boca con acogida giratoria							
7,0cm; 2 3/4"		9,0cm; 3 1/2"		11,0cm; 4 1/3"		13,0cm; 5 1/8"	
MINI	244-682-07	244-682-09	244-682-11	244-682-13			
	244-682-07T Ti	244-682-09T Ti	244-682-11T Ti	244-682-13T Ti			
STANDARD	244-642-07	244-642-09	244-642-11	244-642-13			
	244-642-07T Ti	244-642-09T Ti	244-642-11T Ti	244-642-13T Ti			



CARESOURCE

FOR SCIENTIFIC & LABORATORY EQUIPMENT TR. CO. L.L.C

Email: sales@caresourceglobal.com Mob: +971529418683

Art.Nr.	Beschreibung Description	Size	Spz.
Other items available but not illustrated			
243-007-00	handle for wire saws		
	GIGLI wire saw; price per piece		
243-015-30		30,0cm; 12"	
243-015-40		40,0cm; 16"	
243-015-50		50,0cm; 20"	
243-015-60		60,0cm; 24"	
243-015-70		70,0cm; 28"	
243-040-21	DE VILBISS carnial rongeur; forceps only	21,0cm; 8,4"	
243-073-00	LEYLA brain retractor		
243-073-30	coupling head for; LEYLA brain retractor		
243-073-35	coupling head for LEYLA brain retractor; laterally open		
	brain spatulas	18,0cm; 7,2"	
243-142-01	malleable; 7+9mm		
243-142-02	malleable; 11+13mm		
243-142-03	malleable; 15+18mm		
243-142-04	malleable; 18+22mm		
	AACHEN brain spatulas	20,0cm; 8"	
243-151-08	malleable; 7+8mm		
243-151-11	malleable; 10+11mm		
243-151-14	malleable; 13+14mm		
243-151-17	malleable; 16+17mm		
243-151-20	malleable; 19+20mm		
243-151-25	malleable; 22+25mm		
	HOLSHER nerve root retractors	24,0cm; 9,6"	
243-203-09	curved; 9mm		
243-203-13	curved; 13mm		
	LOVE modif. nerve root retractors	7,0cm; 2,8"	
243-209-03	3,0mm		
243-209-05	5,0mm		
243-209-07	7,0mm		
	LOVE modif. nerve root retractors	10,0cm; 4"	
243-211-03	3,0mm		
243-211-05	5,0mm		
243-211-07	7,0mm		
243-215-21	MARTIN nerve root retractors	21,0cm; 9"	
	HOEN dura dissectors	15,0cm; 6"	
243-233-01			
243-233-02			

CARESOURCE

FOR SCIENTIFIC & LABORATORY EQUIPMENT TR. CO. L.L.C

Email: sales@caresourceglobal.com Mob: +971529418683

Art.Nr.	Beschreibung Description	Size	Spz.
Other items available but not illustrated			
243-262-13	TOENNIS dura knife; pointed	13,0cm; 5,2"	
	disectomy retractor	17,0cm; 6,8"	
243-315-51	left; 50x10mm		
243-315-52	left; 50x20mm		
243-315-61	left; 60x10mm		
243-315-62	left; 60x20mm		
243-315-71	left; 70x10mm		
243-315-72	left; 70x20mm		
243-316-51	right; 50x10mm		
243-316-52	right; 50x20mm		
243-316-61	right; 60x10mm		
243-316-62	right; 60x20mm		
243-316-71	right; 70x10mm		
243-316-72	right; 70x20mm		
243-320-00	HEY disectomy retractor complete		
243-320-01	only		
	HEY cervical awl		
243-321-37	37mm		
243-321-53	53mm		
243-321-62	62mm		
	HEY blade		
243-323-50	sharp; 20x50mm		
243-323-60	sharp; 20x60mm		
243-323-70	sharp; 20x70mm		
243-325-50	blunt; 20x50mm		
243-325-60	blunt; 20x60mm		
243-325-70	blunt; 20x70mm		
243-351-48	CASPAR hooks; 48,0mm; for wound spreader		
	CASPAR blade		
243-353-57	57x37mm; 3 teeth		
243-354-57	57x52mm; 4 teeth		
243-354-80	80x52mm; 4 teeth		
243-360-02	CASPAR retractor; with 2 blades		
243-360-99	CASPAR Retractor Set complete		
	CASPAR blade		
243-361-65	medial; 65x25mm		
243-361-75	medial; 75x25mm		
243-361-85	medial; 85x25mm		
243-363-65	lateral; 65x25mm		
243-363-75	lateral; 75x25mm		



CARESOURCE

FOR SCIENTIFIC & LABORATORY EQUIPMENT TR. CO. L.L.C

Email: sales@caresourceglobal.com Mob: +971529418683

Art.Nr.	Beschreibung Description	Size	Spz.
Other items available but not illustrated			
243-363-85	CASPAR blade lateral; 85x25mm		
243-380-02	CLOWARD lamina spreader		
243-385-12	CASPAR Distraction screw 12mm		
243-385-14	CASPAR Distraction screw 14mm		
243-385-16	CASPAR Distraction screw 16mm		
243-385-18	CASPAR Distraction screw 18mm		
243-385-90	CAPAR Twist drill, 1,7mm; Drillung depth 8mm, 2,35mm		
243-385-95	screw driver; for distraction screw	20,0cm; 8"	
243-390-65	CASPAR wound spreader 65mm		
243-390-70	CASPAR wound spreader 70mm		
243-390-75	CASPAR wound spreader 75mm		
243-390-85	CASPAR wound spreader 80mm		
243-413-65	CASPAR blade lateral, black-coated; 65mm		
243-413-75	CASPAR blade lateral, black-coated; 75mm		
243-413-85	CASPAR blade lateral, black-coated; 85mm		
243-414-65	CASPAR blade medial, black coated; 65mm		
243-414-70	CASPAR blade medial, black coated; 70mm		
243-421-70	SCOVILLE hook blunt; 70mm		
243-422-70	SCOVILLE hook 70mm		
243-423-04	SCOVILLE blade; 89x25 mm		
243-430-00	SCOVILLE-RICHTER wound spreader complete		
243-430-01	SCOVILLE-RICHTER wound spreader only		
243-432-02	SCOVILLE-RICHTER blade; 1 pair 62x52mm		
243-433-01	SCOVILLE-RICHTER blade; 1 pair 47x51mm		
243-433-02	SCOVILLE-RICHTER blade; 1 pair 30x40mm		
243-433-03	SCOVILLE-RICHTER blade; 1 pair 37x62mm		
243-470-30	CLOWARD lamina spreader 30mm		
243-470-50	CLOWARD lamina spreader 50mm		
243-470-60	CLOWARD lamina spreader 60mm		

CARESOURCE

FOR SCIENTIFIC & LABORATORY EQUIPMENT TR. CO. L.L.C

Email: sales@caresourceglobal.com Mob: +971529418683

Art.Nr.	Beschreibung Description	Size	Spz.
Other items available but not illustrated			
	CLOWARD lamina spreader		
243-470-75	75mm		
243-470-90	90mm		
243-471-13	127mm		
243-475-09	9,0cm; 3,6"		
243-475-11	11,0cm; 4,4"		
243-479-21	7x110mm		
	HARMS lamina spreader		
243-490-01	right		
243-490-02	left		
	INGE lamina spreader		
243-499-17	special pattern; 38mm opening	16,5cm; 6,6"	
243-499-27	screw lock instead of ratchet	27,0cm; 10,8"	
243-500-16	BADGLEY lamina spreader; opening 165mm		
243-585-20	HUNT tumor grasping forceps; angled; toothed; Ø 5,0mm	20,0cm; 8"	
	RHOTON dissector	19,0cm; 7,6"	
243-610-01	round; 1mm		
243-610-02	round; 2mm		
243-610-03	round; 3mm		
243-610-04	round; 1mm; spatula shaped		
243-610-05	round; 1,5mm; spatula shaped		
243-610-06	round; 2mm; spatula shaped		
	RHOTON elevator	19,0cm; 7,6"	
243-610-07	1,2mm		
243-610-08	2,8mm		
243-610-09	semi sharp		
243-610-10	90°; 2mm; blunt		
243-610-11	90°; 2mm; semi sharp		
243-610-12	45°; 3mm; semi sharp		
243-610-13	angled		
	RHOTON curette	19,0cm; 7,6"	
243-610-14	ova; 1x2mm		
243-610-15	oval; 45°; 1x2mm		
	CASPAR micro instrument		
243-632-01		23,0cm; 9,2"	
243-632-02		23,0cm; 9,2"	
243-637-01		21,0cm; 8,4"	
243-637-02		21,0cm; 8,4"	
	micro instrument		
243-641-19	18,5cm; 7,4"		
243-641-21	21,5cm; 8,6"		



CARESOURCE

FOR SCIENTIFIC & LABORATORY EQUIPMENT TR. CO. L.L.C

Email: sales@caresourceglobal.com Mob: +971529418683

Art.Nr.	Beschreibung Description	Size	Spz.
Other items available but not illustrated			
	SAMII micro instrument	20,0cm; 8"	
243-649-10			
243-649-15			
243-649-20			
243-649-25			
243-649-30			
243-649-35			
243-649-40			
243-649-50			
243-651-10	SAMII micro tumor knife; 1,0mm; 23,0cm	23,0cm; 9,2"	
	SAMII micro instrument	23,0cm; 9,2"	
243-651-15			
243-651-20			
243-651-25	SAMII micro tumor knife; 2,5mm	23,0cm; 9,2"	
243-651-30	SAMII micro instrument	23,0cm; 9,2"	
243-651-35	SAMII micro tumor knife; 3,5mm	23,0cm; 9,2"	
	SAMII micro instrument	23,0cm; 9,2"	
243-651-40			
243-651-50			
	SAMII micro tumor knife	23,0cm; 9,2"	
243-652-15	1,5mm		
243-652-30	3,0mm		
243-652-45	4,5mm		
243-652-60	6,0mm		
243-671-19	KRAUS micro instrument; curved; bayonet	18,5cm; 7,4"	
243-680-23	CASPAR knot tier and ligature adjuster; bayonet shape	23,0cm; 9,2"	
	OKONEK-YASARGIL micro instrument		
243-682-03	3mm		
243-682-04	4mm		
243-682-05	5mm		
243-682-08	8mm		
	Vessel dilator	12,5cm; 5"	
243-690-01	Ø 1,5mm		
243-690-02	Ø 0,5mm		
243-690-03	Ø 1,0mm		
243-710-17	FAHLBUSCH micro instrument	16,5cm; 6,6"	
243-716-30	NIKOLA micro instrument; 30° upwards; 2mm; straight; oval tip;	20,0cm; 8"	

CARESOURCE

FOR SCIENTIFIC & LABORATORY EQUIPMENT TR. CO. L.L.C

Email: sales@caresourceglobal.com Mob: +971529418683

Art.Nr.	Beschreibung Description	Size	Spz.
Other items available but not illustrated			
243-717-16	NIKOLA micro instrument curved right; 2mm; oval tip;	20,0cm; 8"	
243-719-16	curved left; 2mm; oval tip;		
243-726-30	30° upwards; 2mm; straight; round tip;		
243-727-16	curved right; 2mm; round tip;		
243-729-16	curved left; 2mm; round tip;		
243-730-35	YASARGIL hypophysectomy spoon cup fcps Ø 3,5mm	18,0cm; 7,2"	
243-730-35CC	Ø 3,5mm; ceramic coated		
243-736-21	LANDOLT pituitary instrument; 9mm	20,0cm; 8"	
243-740-18	OLDBERG hypophysectomy forceps; Ø 7mm	18,0cm; 7,2"	
243-750-03	micro instrument 3mm	14,0cm; 5,6"	
243-750-07	7mm		
243-750-09	9mm		
243-750-12	12mm		
243-752-03	micro instrument 3mm	18,0cm; 7,2"	
243-752-07	7mm		
243-752-09	9mm		
243-752-12	12mm		
243-804-04	CONE micro curette Ø 4,0mm; straight	23,0cm; 9,2"	
243-804-07	Ø 7,0mm; straight		
243-804-09	Ø 9,0mm; straight		
243-805-04	Ø 4,0mm; angled		
243-805-07	Ø 7,0mm; angled		
243-805-09	Ø 9,0mm; angled		
243-807-04	KRÄMER hypophysectomy ring curette Ø 4,0mm; bayonet shaped	25,0cm; 10"	
243-807-05	Ø 5,0mm; bayonet shaped		
243-807-06	Ø 6,0mm; bayonet shaped		
243-810-03	RAY pituitary instrument; 3,0mm; 45° sideways	18,0cm; 7,2"	
243-818-02	HARDY pituitary instrument; 2,0mm	26,0cm; 10,4"	
243-823-22	NICOLA hypophysectomy instrument curette; flexible; left side cut.; Ø6,5mm	22,0cm; 8,8"	
243-824-22	NICOLA pituitary instrument	21,5cm; 8,6"	
243-825-22			



CARESOURCE

FOR SCIENTIFIC & LABORATORY EQUIPMENT TR. CO. L.L.C

Email: sales@caresourceglobal.com Mob: +971529418683

Art.Nr.	Beschreibung Description	Size	Spz.
Other items available but not illustrated			
243-826-22	NICOLA pituitary instrument	21,5cm; 8,6"	
243-844-01	LANDOLT pituitary instrument malleable; blunt; right	26,0cm; 10,4"	
243-844-02	malleable; blunt; right		
243-845-26	malleable		
243-846-26	malleable		
243-847-26	malleable; blunt		
243-850-26	FAHLBUSCH pituitary instrument malleable	26,0cm; 10,4"	
243-851-26	curette; malleable; Ø 2,5mm		
243-854-26	HOSOBUCHI pituitary instrument	26,0cm; 10,4"	
243-857-22	LANDOLT-REULEN pituitary instrument raspatory; rigid; Ø 2,2mm	26,0cm; 10,4"	
243-857-32	raspatory; rigid; Ø 3,2mm		
243-859-25	curette; rigid; Ø 2,5mm		
243-861-17	hook; rigid; blunt; Ø 1,7mm		
243-862-20	2,0mm		
243-864-23	micro dissector; bayonet shaped; upwards curved	23,0cm; 9,2"	
243-870-03	HARDY pituitary curette bayonet shaped; straight; angled up; Ø 3,0mm	24,0cm; 9,6"	
243-870-05	bayonet shaped; straight; angled up; Ø 5,0mm		
243-871-03	bayonet shaped; straight; angled down; Ø 3,0mm		
243-871-05	bayonet shaped; straight; angled down; Ø 5,0mm		
243-873-03	bayonet shaped; straight; 90° left; Ø 3,0mm		
243-873-05	bayonet shaped; straight; 90° left; Ø 5,0mm		
243-875-03	bayonet shaped; straight; 45° right; Ø 3,0mm		
243-875-05	bayonet shaped; straight; 45° right; Ø 5,0mm		

Weitere Artikel
further items
más artículos

CARESOURCE

FOR SCIENTIFIC & LABORATORY EQUIPMENT TR. CO. L.L.C

Email: sales@caresourceglobal.com Mob: +971529418683

Art.Nr.	Beschreibung Description	Size	Spz.
Other items available but not illustrated			
	applying forceps		
244-140-01	for small clips	16,0cm; 6,4"	
244-140-02	for medium clips	16,0cm; 6,4"	
244-141-01	for medium-large clips	19,0cm; 7,6"	
244-142-01	for small clips	20,0cm; 8"	
244-142-02	for medium clips	20,0cm; 8"	
244-142-03	for large clip	20,0cm; 8"	
Mc KENZIE clip applying forcep; straight			
244-160-15	15,0cm; 6"		
244-160-19	19,0cm; 7,6"		
YASARGIL applying forceps; bayonet shaped for vessel clips; rotatable, jaws in titan			
244-603-23T			
244-613-23T			

CARESOURCE

FOR SCIENTIFIC & LABORATORY EQUIPMENT TR. CO. L.L.C

Email: sales@caresourceglobal.com Mob: +971529418683

Alphabetisches Verzeichnis

A			
Anlegezange, YASARGIL.....	244.75- 244.77		
AUSTIN, Mikro-Knüppelziette.....	243.38		
B			
BADGLEY, Wundspreizer.....	243.31		
C			
CASPAR, Drehschlüssel.....	243.19, 243.20		
CASPAR, Explorationshaken.....	243.41		
CASPAR, Haken.....	243.19, 243.20		
CASPAR, Hypophysektomie-Kürette.....	243.45		
CASPAR, Spektula.....	243.26, 243.27		
CASPAR, Valve.....	243.19, 243.21- 243.28		
CASPAR, Wundspreizer.....	243.19, 243.22, 243.24, 243.25, 243.27		
CLOWARD, Valve.....	243.32, 243.33		
CLOWARD, Wirbelkörperspreizer.....	243.34		
CLOWARD, Wundspreizer.....	243.32, 243.33		
CONE, Schädelstanzzange.....	243.4		
CRUTCHFIELD, Schädelhalter.....	243.5		
CRUTCHFIELD, Vorbohrer.....	243.5		
CUSHING, Durahaken.....	243.15		
CUSHING, Hirnspatel.....	243.12		
D			
DAHLGREEN, Ersatzklinge.....	243.4		
DAHLGREEN, Schädelstanze.....	243.4		
DAVIS, Gefäßspatel.....	243.17		
DE MARTEL, Umführungsinstrument.....	243.2		
DE VILBISS, Ersatzklinge.....	243.3		
DE VILBISS, Schädelstanze.....	243.3		
Dissektor, Dura.....	243.17		
Dissektor, Dura-, FRAZIER.....	243.16		
Dissektor, Dura-, MILLIGAN.....	243.17		
Dissektor, Dura-, OLIVECRONA.....	243.16		
Dissektor, Dura-, PENFIELD.....	243.18		
Dissektor, Dura-, SACHS.....	243.16		
Dissektor, Mikro-Instrument.....	243.40		
Drahtsäge, OLIVECRONA.....	243.2		
Drehschlüssel, CASPAR.....	243.19, 243.20		
Duradissektor.....	243.17		
Duradissektor, FRAZIER.....	243.16		
Duradissektor, MILLIGAN.....	243.17		
Duradissektor, OLIVECRONA.....	243.16		
Duradissektor, PENFIELD.....	243.18		
Duradissektor, SACHS.....	243.16		
Durahaken, CUSHING.....	243.15		
E			
Ersatzklinge, DAHLGREEN.....	243.4		
Ersatzklinge, DE VILBISS.....	243.3		
Explorationshaken, CASPAR.....	243.41		
F			
Fadenführer, YASARGIL.....	243.44		
Fixiervorrichtung, LEYLA.....	243.7, 243.10		
FRAZIER, Duradissektor.....	243.16		
G			
Galea Haken, YASARGIL.....	244.51		
Gefäßspatel, DAVIS.....	243.17		
Gefäßspatel, TOENNIS.....	243.17		
Gewebekralle.....	243.44		
GIGLI, Hakengriff.....	243.2		
Griff, Haken-, GIGLI.....	243.2		
H			
Haken, CASPAR.....	243.19, 243.20		
Haken, Dura-, CUSHING.....	243.15		
Haken, Explorations-, CASPAR.....	243.41		
Haken, Galea, YASARGIL.....	244.51		
Haken, Nerv-, SMITHWICK.....	243.15		
Haken, Nervwurzel-, HOLSHER.....	243.13		
Haken, Nervwurzel-, HORSLEY.....	243.13		
Haken, Nervwurzel-, LOVE.....	243.14		
Haken, Nervwurzel-, SACHS.....	243.13		
Haken, Nervwurzel-, SCOVILLE.....	243.13		
Haken, SCOVILLE.....	243.29, 243.30		
Hakengriff, GIGLI.....	243.2		
Haltearm, LEYLA.....	243.8, 243.9		
HARDY, Hypophysektomie-Instrument.....	243.47		
HARDY, Kürette.....	243.46		
HARDY-FAHLBUSCH, Hypophysektomie-Instrument.....	243.47		
HEIFETZ, Hirnspatel.....	243.11		
HEIFETZ, Tumorfalßpinzette.....	243.36		
Hirnretraktor, LEYLA.....	243.7- 243.9		
Hirnspatel.....	243.12		
Hirnspatel, CUSHING.....	243.12		
Hirnspatel, HEIFETZ.....	243.11		
Hirnspatel, OLIVECRONA.....	243.11, 243.12		
HOLSHER, Nervwurzelhaken.....	243.13		
HORSLEY, Nervwurzelhaken.....	243.13		
Hypophysektomie-Instrument, HARDY.....	243.47		
Hypophysektomie-Instrument, HARDY-FAHLBUSCH.....	243.47		
Hypophysektomie-Kürette, CASPAR.....	243.45		
Hypothesen-Zange, YASARGIL.....	243.45		
I			
INGE, Wirbelkörperspreizer.....	243.34, 243.35		
J			
JACOBSON, Mikro-Instrument.....	243.44		
K			
Klammeranlegezange, MC KENZIE.....	244.48		
Klammeranlegezange, OLIVECRONA-TOENNIS.....	244.48		
L			
Klinge, Ersatz-, DAHLGREEN.....	243.4		
Klinge, Ersatz-, DE VILBISS.....	243.3		



CARESOURCE

FOR SCIENTIFIC & LABORATORY EQUIPMENT TR. CO. L.L.C

Email: sales@caresourceglobal.com Mob: +971529418683

Alphabetisches Verzeichnis

Knüpfpinzette, Mikro	243.37- 243.39
KOOS, Mikro-Instrument	243.43

Kopfhautklammerzange, RANEY	244.48
Kugelgelenkkolben, LEYLA	243.8, 243.9
Kupplungskopf, LEYLA	243.8, 243.9
Kürette, HARDY	243.46
Kürette, Hypophysektomie-, CASPAR	243.45
Kürette, Mikro-Instrument, RAY	243.46

L	
LAZAR, Mikro-Knüpfpinzette	243.39
LEYLA, Fixiervorrichtung	243.7, 243.10
LEYLA, Haltearm	243.8, 243.9
LEYLA, Hirnretraktor	243.7- 243.9
LEYLA, Kugelgelenkkolben	243.8, 243.9
LEYLA, Kupplungskopf	243.8, 243.9
LEYLA, Spannarm	243.7- 243.10
LEYLA, Spatelhalter	243.7- 243.10
LOVE, Nervwurzelhaken	243.14

M	
MC KENZIE, Klammeranlegezange	244.48
MC KENZIE, Klammerblock	244.49
Mikro-Instrument Kürette, RAY	243.46
Mikro-Instrument, Dissektor	243.40
Mikro-Instrument, Häckchen	243.40
Mikro-Instrument, JACOBSON	243.44
Mikro-Instrument, KOOS	243.43
Mikro-Instrument, Löffel	243.40
Mikro-Instrument, Raspatorium	243.40
Mikro-Instrument, YASARGIL	243.42, 243.43
Mikro-Knüpfpinzette	243.37- 243.39
Mikro-Knüpfpinzette, AUSTIN	243.38
Mikro-Knüpfpinzette, LAZAR	243.39
Mikro-Knüpfpinzette, VISE	243.38
Mikro-Pinzette	243.37
Mikro-Pinzette, YASARGIL	243.35
MILLIGAN, Duradisektor	243.17

N	
Nervhaken, SMITHWICK	243.15
Nervwurzelhaken, HOLSHER	243.13
Nervwurzelhaken, HORSLEY	243.13
Nervwurzelhaken, LOVE	243.14
Nervwurzelhaken, SACHS	243.13
Nervwurzelhaken, SCOVILLE	243.13, 243.14

O	
OLIVECRONA, Drahtsäge	243.2
OLIVECRONA, Duradisektor	243.16
OLIVECRONA, Hirnspatel	243.11, 243.12
OLIVECRONA-TOENNIS, Klammeranlegezange	244.48

P	
PENFIELD, Duradisektor	243.18
Pinzette zum Valvenwechseln	243.24
Pinzette-, Mikro	243.37

R	
RANEY, Kopfhautklammerzange	244.48
Raspatorium, Mikro-Instrument	243.40
RAY, Mikro-Instrument Kürette	243.46
Retraktor, Hirn-, LEYLA	243.7- 243.9

S	
SACHS, Duradisektor	243.16
SACHS, Nervwurzelhaken	243.13
Säge, Draht-, OLIVECRONA	243.2
SAMII, Tumorfalpinzette	243.36
Schädelhalter	243.6
Schädelhalter, CRUTCHFIELD	243.5
Schädelstanzzange, CONE	243.4
Schädelstanze, DAHLGREEN	243.4
Schädelstanze, DE VILBISS	243.3
SCOVILLE, Haken	243.29, 243.30
SCOVILLE, Nervwurzelhaken	243.13, 243.14
SCOVILLE, Valve	243.29- 243.31
SCOVILLE, Wundspreizer	243.29
SCOVILLE-HAVERFIELD, Wundspreizer	243.30
Silberklammern	244.49
SMITHWICK, Nervhaken	243.15
Spannarm, LEYLA	243.7- 243.10
Spatel, Gefäß-, DAVIS	243.17
Spatel, gefäß-, TOENNIS	243.17
Spatel, Hirn-	243.12
Spatel, Hirn-, CUSHING	243.12
Spatel, Hirn-, HEIFETZ	243.11
Spatel, Hirn-, OLIVECRONA	243.11, 243.12
Spatelhalter, LEYLA	243.7- 243.10
Spekula, CASPAR	243.26, 243.27
Spreizer, Wirbelkörper-, CLOWARD	243.34
Spreizer, Wirbelkörper-, INGE	243.35
Spreizer, Wund-, BADGLEY	243.31
Spreizer, Wund-, CASPAR	243.19, 243.22, 243.24, 243.25,
	243.27
Spreizer, Wund-, CLOWARD	243.32, 243.33
Spreizer, Wund-, SCOVILLE	243.29
Spreizer, Wund-, SCOVILLE-HAVERFIELD	243.30
Stanze, Schädel-, DAHLGREEN	243.4
Stanze, Schädel-, DE VILBISS	243.3

T	
TAYLOR, Valve	243.31
TOENNIS, Gefäßspatel	243.17
Tumorfalpinzette, HEIFETZ	243.36
Tumorfalpinzette, SAMII	243.36
Tumorfalpinzette, YASARGIL	243.35, 243.36
Tumorfalpinzette, YASARGIL-SAMII	243.35

CARESOURCE

FOR SCIENTIFIC & LABORATORY EQUIPMENT TR. CO. L.L.C

Email: sales@caresourceglobal.com

Mob: +971529418683

Alphabetisches Verzeichnis

U

Umführungsinstrument, DE MARTEL.....243.2

V

Valve, CASPAR.....243.19, 243.21- 243.28

Valve, CLOWARD.....243.32, 243.33

Valve, SCOVILLE.....243.29- 243.31

Valve, TAYLOR.....243.31

VISE, Mikro-Knüpfpinzette.....243.38, 243.39

Vorbohrer, CRUTCHFIELD.....243.5

W

Wirbelkörperspreizer, CLOWARD.....243.34

Wirbelkörperspreizer, INGE.....243.34, 243.35

Wundspreizer, BADGLEY.....243.31

Wundspreizer, CASPAR.....243.19, 243.22, 243.24, 243.25, 243.27

Wundspreizer, CLOWARD.....243.32, 243.33

Wundspreizer, SCOVILLE.....243.29

Wundspreizer, SCOVILLE-HAVERFIELD.....243.30

Y

YASARGIL, Anlegezange.....244.75- 244.77

YASARGIL, Fadenführer.....243.44

YASARGIL, Galea Haken.....244.51

YASARGIL, Hypothesen-Zange.....243.45

YASARGIL, Mikro-Instrument.....243.42, 243.43

YASARGIL, Mikro-Pinzette.....243.35

YASARGIL, Tumorfaßpinzette.....243.35, 243.36

YASARGIL-SAMII, Tumorfaßpinzette.....243.35

Z

Zange, Anlege-, YASARGIL.....244.75- 244.77

Zange, Hypothesen-, YASARGIL.....243.45

Zange, Klammeranlege-, MC KENZIE.....244.48

Zange, Klammeranlege-, OLIVECRONA-TOENNIS.....244.48

Zange, Kopfhautklammer-, RANEY.....244.48

Zange, Schädelstanz-, CONE.....243.4



CARESOURCE

FOR SCIENTIFIC & LABORATORY EQUIPMENT TR. CO. L.L.C

Email: sales@caresourceglobal.com Mob: +971529418683

Index, alphabetical

A		DE VILBISS, cranial punch	243.3
applying forceps, RANEY	244.48	DE VILBISS, spare blade	243.3
applying forceps, YASARGIL	244.75- 244.77	dissector, dura	243.17
AUSTIN, micro tying forceps	243.38	dissector, dura, FRAZIER	243.16
B		dissector, dura, MILLIGAN	243.17
BADGLEY, wound spreader	243.31	dissector, dura, OLIVECRONA	243.16
ball and socket joint, LEYLA	243.8, 243.9	dissector, dura, PENFIELD	243.18
blade, CASPAR	243.19, 243.21- 243.28	dissector, dura, SACHS	243.16
blade, CLOWARD	243.32, 243.33	dissector, micro instrument	243.40
blade, SCOVILLE	243.29- 243.31	drill point, CRUTCHFIELD	243.5
blade, spare, DAHLGREEN	243.4	dura dissector	243.17
blade, spare, DE VILBISS	243.3	dura dissector, FRAZIER	243.16
blade, TAYLOR	243.31	dura dissector, MILLIGAN	243.17
brain retractor, LEYLA	243.7- 243.10	dura dissector, OLIVECRONA	243.16
brain spatula	243.12	dura dissector, PENFIELD	243.18
brain spatula, CUSHING	243.12	dura dissector, SACHS	243.16
brain spatula, HEIFETZ	243.11	dura hook, CUSHING	243.15
brain spatula, OLIVECRONA	243.11, 243.12	E	
C		exploration hook, CASPAR	243.41
CASPAR, blade	243.19, 243.21- 243.28	F	
CASPAR, exploration hook	243.41	fixation base, LEYLA	243.7, 243.7
CASPAR, hook	243.19, 243.20	flexible arm, LEYLA	243.7- 243.10
CASPAR, key	243.19, 243.20	forceps for changing valves	243.24
CASPAR, micro curette	243.45	forceps, applying, YASARGIL	244.75- 244.77
CASPAR, specula	243.26- 243.27	forceps, clip applying, MC KENZIE	244.48
CASPAR, wound spreader	243.19, 243.22, 243.24, 243.25,	forceps, clip applying, OLIVECRONA-TOENNIS	244.48
	243.27	forceps, pituitary, YASARGIL	243.45
clip applying forceps, MC KENZIE	244.48	FRAZIER, dura dissector	243.16
clip applying forceps, OLIVECRONA-TOENNIS	244.48	G	
CLOWARD, blade		galea hook, YASARGIL	244.51
243.32, 243.33		GIGLI, hook handle	243.2
CLOWARD, lamina spreader	243.34	H	
CLOWARD, wound spreader	243.32, 243.33	handle, hook, GIGLI	243.2
conductor, DE MARTEL	243.2	HARDY, curette	243.46
CONE, cranial punch rongeur	243.4	HARDY, pituitary instrument	243.47
coupling head, LEYLA	243.8, 243.9	HARDY-FAHLBUSCH, pituitary instrument	243.47
cranial punch rongeur, CONE	243.4	HEIFETZ, brain spatula	243.11
cranial punch, DAHLGREEN	243.4	HEIFETZ, tumor grasping forceps	243.36
cranial punch, DE VILBISS	243.3	holding rod, LEYLA	243.8, 243.9
CRUTCHFIELD, drill point	243.5	HOLSHER, nerve root retractor	243.13
CRUTCHFIELD, skull traction tong	243.5	hook handle, GIGLI	243.2
curette, HARDY	243.46	hook, CASPAR	243.19, 243.20
curette, micro, CASPAR	243.45	hook, dura, CUSHING	243.15
curette, micro, RAY	243.46	hook, exploration, CASPAR	243.41
CUSHING, brain spatula	243.12	hook, galea, YASARGIL	244.51
CUSHING, dura hook	243.15	hook, nerve, SMITHWICK	243.15
D		hook, SCOVILLE	243.29, 243.30
DAHLGREEN, cranial punch	243.4	HORSLEY, nerve root retractor	243.13
DAHLGREEN, spare blade	243.4	I	
DAVIS, vascular spatula	243.17	INGE, lamina spreader	243.34, 243.35
DE MARTEL, conductor	243.2		

CARESOURCE

FOR SCIENTIFIC & LABORATORY EQUIPMENT TR. CO. L.L.C

Email: sales@caresourceglobal.com

Mob: +971529418683

Index, alphabetical

J			P	
JACOBSON, micro instrument.....	243.44		PENFIELD, dura dissector.....	243.18
			periosteal elevator, micro instrument	243.40
K			pituitary forceps, YASARGIL	243.45
key, CASPAR	243.19, 243.20		pituitary instrument, HARDY	243.47
KOOS, micro instruments	243.43		pituitary instrument, HARDY-FAHLBUSCH	243.47
			punch, cranial, DAHLGREEN	243.4
L			punch, cranial, DE VILBISS	243.3
lamina spreader, CLOWARD	243.34			
lamina spreader, INGE.....	243.34, 243.35		R	
LAZAR, micro tying forceps	243.39		RANEY, applying forceps	244.48
LEYLA, ball and socket join.....	243.8, 243.9			
LEYLA, brain retractor.....	243.7- 243.9		RAY, micro curette	243.46
LEYLA, coupling head	243.8, 243.9		retractor, brain, LEYLA	243.7- 243.9
LEYLA, fixation base	243.7, 243.10		retractor, nerve root, HORSLEY	243.13
LEYLA, flexible arm	243.7- 243.10		retractor, nerve root, LOVE	243.14
LEYLA, holding rod	243.8, 243.9		retractor, nerve root, SACHS	243.13
LEYLA, support	243.7- 243.10		retractor, nerve root, SCOVILLE	243.13, 243.14
ligature guide and carrier, YASARGIL.....	243.44		rongeur, cranial punch, CONE.....	243.4
LOVE, nerve root retractor.....	243.14			
			S	
M			SACHS, dura dissector	243.16
MC KENZIE, clip applying forceps	244.48		SACHS, nerve root retractor	243.13
			SAMII, tumor grasping forceps	243.36
micro curette, CASPAR	243.45		saw, wire, OLIVECRONA	243.2
micro curette, RAY	243.46			
micro forceps	243.37		SCOVILLE, blade.....	243.29, 243.30
micro forceps, YASARGIL	243.35		SCOVILLE, nerve root retractor.....	243.13, 243.14
micro instrument, dissector.....	243.40		SCOVILLE, wound spreader	243.29
micro instrument, hook	243.40		SCOVILLE-HAVERFIELD, wound spreader.....	243.30
micro instrument, JACOBSON.....	243.44			
micro instrument, KOOS	243.43		skull traction tong.....	243.6
micro instrument, periosteal elevator	243.40		skull traction tong, CRUTCHFIELD	243.5
micro instrument, spoon	243.40		SMITHWICK, nerve hook	243.15
micro instrument, YASARGIL	243.42, 243.43		spare blade, DAHLGREEN	243.4
micro tying forceps	243.37- 243.39		spare blade, DE VILBISS	243.3
micro tying forceps, AUSTIN.....	243.38		spare pin	243.6
micro tying forceps, LAZAR	243.39		spatula, brain	243.12
micro tying forceps, VISE	243.38, 243.39		spatula, brain, CUSHING	243.12
MILLIGAN, dura dissector.....	243.17		spatula, brain, HEIFETZ	243.11
			spatula, brain, OLIVECRONA	243.11, 243.12
N			spatula, vascular, DAVIS	243.17
nerve hook, SMITHWICK	243.15		spatula, vascular, TOENNIS	243.17
nerve root retractor, HOLSHER	243.13		specula, CASPAR	243.26, 243.27
nerve root retractor, HORSLEY	243.13		spreader, lamina, CLOWARD	243.34
nerve root retractor, LOVE	243.14		spreader, lamina, INGE.....	243.34, 243.35
nerve root retractor, SACHS.....	243.13		spreader, wound, BADGLEY	243.31
nerve root retractor, SCOVILLE	243.13, 243.14		spreader, wound, CASPAR	243.19, 243.22, 243.24, 243.25,
				243.27
O			spreader, wound, CLOWARD	243.32, 243.33
OLIVECRONA, brain spatula	243.11, 243.12		spreader, wound, SCOVILLE	243.29
OLIVECRONA, dura dissector.....	243.16		spreader, wound, SCOVILLE-HAVERFIELD	243.30
OLIVECRONA, wire saw.....	243.2		support, LEYLA	243.7- 243.10
OLIVECRONA-TOENNIS, clip applying forceps.....	244.48			



CARESOURCE

FOR SCIENTIFIC & LABORATORY EQUIPMENT TR. CO. L.L.C

Email: sales@caresourceglobal.com

Mob: +971529418683

Index, alphabetical

T

TAYLOR, blade	243.31
tissue claw	243.44
TOENNIS, vascular spatula	243.17
tumor grasping forceps, HEIFETZ	243.36
tumor grasping forceps, SAMII	243.36
tumor grasping forceps, YASARGIL	243.35, 243.36
tumor grasping forceps, YASARGIL-SAMII	243.35

V

vascular spatula, DAVIS	243.17
vascular spatula, TOENNIS	243.17
VISE, micro tying forceps	243.38, 243.39

W

wire saw, OLIVECRONA	243.2
wound spreader, BADGLEY	243.31
wound spreader, CASPAR	243.19, 243.22, 243.24, 243.25, 243.27
wound spreader, CLOWARD	243.32, 243.33
wound spreader, SCOVILLE	243.29
wound spreader, SCOVILLE-HAVERFIELD	243.30

Y

YASARGIL, applying forceps	244.75- 244.77
YASARGIL, galea hook	244.51
YASARGIL, ligature guide and carrier	243.44
YASARGIL, micro forceps	243.35
YASARGIL, micro instrument	243.42, 243.43
YASARGIL, pituitary forceps	243.45
YASARGIL, tumor grasping forceps	243.35, 243.36
YASARGIL-SAMII, tumor grasping forceps	243.35

CARESOURCE

FOR SCIENTIFIC & LABORATORY EQUIPMENT TR. CO. L.L.C

Email: sales@caresourceglobal.com

Mob: +971529418683

Indice, alfabético

A		FRAZIER, disecador para duramadre	243.16
acoplamiento, LEYLA	243.8, 243.9		
AUSTIN, micro-pinzas de ligadura	243.38		
B		G	
BADGLEY, separador autoestático	243.31	galea gancho, YASARGIL	244.51
brazo, LEYLA	243.7- 243.10	gancho para duramadre, CUSHING	243.15
C		gancho para exploración, CASPAR	243.41
CASPAR, espéculo para la columna	243.26, 243.27	gancho para nervios, SMITHWICK	243.15
CASPAR, gancho	243.19, 243.20	gancho, CASPAR	243.19, 243.20
CASPAR, gancho para exploración	243.41	gancho, SCOVILLE	243.29, 243.30
CASPAR, llave	243.19, 243.20	garra para el tejido	243.44
CASPAR, micro cucharillas	243.45	GIGLI, mango	243.2
CASPAR, separador autoestático	243.19, 243.22, 243.24,		
	243.25, 243.27	guia-ligadura, YASARGIL	243.44
CASPAR, valva	243.19, 243.21- 243.28	guia-sierra, DE MARTEL	243.2
cerebral, espátula	243.12	H	
C		HARDY, cucharillas	243.46
CLOWARD, separador autoestático	243.32, 243.33	HARDY, instrumento para la hipf sectomia	243.47
CLOWARD, separador cuerpos vertebrales	243.34	HARDY-FAHLBUSCH, instrumento para la hipf sectomia	243.47
CLOWARD, valva	243.32, 243.33	HEIFETZ, espátula cerebral	243.11
CONE, pinza saca-bocados craneal	243.4	HEIFETZ, pinza para agarrar tumores	243.36
CRUTCHFIELD, perforador	243.5	hoja de repuesto, DAHLGREEN	243.4
CRUTCHFIELD, tractor craneal	243.5	hoja de repuesto, DE VILBISS	243.3
cucharillas, HARDY	243.46	HÖLSHER, separador para la raíz nervio	243.13
CUSHING, espátula cerebral	243.12	HORSLEY, separador para la raíz nervio	243.13
CUSHING, gancho para duramadre	243.15	I	
D		INGE, separador cuerpos vertebrales	243.34, 243.35
DAHLGREEN, hoja de repuesto	243.4	instrumento para la hipf sectomia, HARDY	243.47
DAHLGREEN, pinza sacabocado craneal	243.4	instrumento para la hipf sectomia, HARDY-FAHLBUSCH	243.47
DAVIS, disecador para duramadre	243.17	instrumento para microcirugia, chucharilla	243.40
DE MARTEL, guia-sierra	243.2	instrumento para microcirugia, disecador	243.40
DE VILBISS, hoja de repuesto	243.3	instrumento para microcirugia, gancho	243.40
DE VILBISS, pinza sacabocado craneal	243.3	instrumento para microcirugia, JACOBSON	243.44
disecador para duramadre	243.17	instrumento para microcirugia, KOOS	243.43
disecador para duramadre, DAVIS	243.17	instrumento para microcirugia, legra	243.40
disecador para duramadre, FRAZIER	243.16	instrumento para microcirugia, YASARGIL	243.42, 243.43
disecador para duramadre, MILLIGAN	243.17	J	
disecador para duramadre, OLIVECRONA	243.16	JACOBSON, instrumento para microcirugia	243.44
disecador para duramadre, PENFIELD	243.18	K	
disecador para duramadre, SACHS	243.16	KOOS, instrumento para microcirugia	243.43
disecador para duramadre, TOENNIS	243.17	L	
disecador, instrumento para microcirugia	243.40	LAZAR, micro-pinzas de ligadura	243.39
E		legra, instrumento para microcirugia	243.40
espéculo para la columna, CASPAR	243.26, 243.27	LEYLA, acoplamiento	243.8, 243.9
espátula cerebral	243.12	LEYLA, brazo	243.7- 243.10
espátula cerebral, CUSHING	243.12	LEYLA, fijador	243.7- 243.10
espátula cerebral, HEIFETZ	243.11	LEYLA, porta-espátula	243.7- 243.10
espátula cerebral, OLIVECRONA	243.11, 243.12	LEYLA, separador cerebro	243.7- 243.9
espina de repuesto	243.6	LEYLA, zapato para la fijacion	243.8, 243.9
F		lave, CASPAR	243.19, 243.20
fijador, LEYLA	243.7- 243.10		



CARESOURCE

FOR SCIENTIFIC & LABORATORY EQUIPMENT TR. CO. L.L.C

Email: sales@caresourceglobal.com Mob: +971529418683

Indice, alfabético

LOVE, separador para la raíz nervio..... 243.14

M

mango, GIGLI..... 243.2

MC KENZIE, pinza para poner grapas..... 244.48

micro cucharillas, CASPAR..... 243.45

micro cucharillas, RAY..... 243.46

micro pinza..... 243.37

micro pinza, YASARGIL..... 243.35

micro-pinzas de ligadura..... 243.37- 243.39

micro-pinzas de ligadura, AUSTIN..... 243.38

micro-pinzas de ligadura, LAZAR..... 243.39

MILLIGAN, disecador para duramadre..... 243.17

O

OLIVECRONA, disecador para duramadre..... 243.16

OLIVECRONA, espátula cerebral..... 243.11, 243.12

OLIVECRONA, sierra de hilo..... 243.2

OLIVECRONA-TOENNIS, pinza para poner grapas..... 244.48

P

PENFIELD, disecador para duramadre..... 243.18

perforador, CRUTCHFIELD..... 243.5

pinza para agarrar tumores, HEIFETZ..... 243.36

pinza para agarrar tumores, SAMIL..... 243.36

pinza para agarrar tumores, YASARGIL..... 243.35, 243.36

pinza para agarrar tumores, YASARGIL-SAMII..... 243.35

pinza para aplicar, YASARGIL..... 244.75- 244.77

pinza para aplicar agrafes, RANEY..... 244.48

pinza para el cambio de valves..... 243.24

pinza para poner grapas, MC KENZIE..... 244.48

pinza para poner grapas, OLIVECRONA-TOENNIS..... 244.48

pinza sacabocado craneal, DAHLGREEN..... 243.4

pinza sacabocado craneal, DE VILBISS..... 243.3

pinza saca-bocados craneal, CONE..... 243.4

pinza, YASARGIL..... 243.45

porta-espátula, LEYLA..... 243.7- 243.10

R

RANEY, pinza para aplicar agrafes..... 244.48

RAY, micro cucharillas..... 243.46

S

SACHS, disecador para duramadre..... 243.16

SACHS, separador para la raíz nervio..... 243.13

SAMII, pinza para agarrar tumores..... 243.36

SCOVILLE, gancho..... 243.29, 243.30

SCOVILLE, separador autoestático..... 243.29

SCOVILLE, separador para la raíz de nervio..... 243.13, 243.14

SCOVILLE, valva..... 243.29- 243.31

SCOVILLE-HAVERFIELD, separador autoestático..... 243.30

separador autoestático, BADGLEY..... 243.31

separador autoestático, CASPAR..... 243.19, 243.22- 243.25

separador autoestático, CLOWARD..... 243.32, 243.33

separador autoestático, SCOVILLE..... 243.29

separador autoestático, SCOVILLE-HAVERFIELD..... 243.30

separador cerebro, LEYLA..... 243.7- 243.9

separador cuerpos vertebrales, CLOWARD..... 243.34

separador cuerpos vertebrales, INGE..... 243.34, 243.35

separador para la raíz nervio, HOLSHER..... 243.13

separador para la raíz nervio, HORSLEY..... 243.13

separador para la raíz nervio, LOVE..... 243.14

separador para la raíz nervio, SACHS..... 243.13

separador para la raíz nervio, SCOVILLE..... 243.13, 243.14

sierra de hilo, OLIVECRONA..... 243.2

SMITHWICK gancho para nervios..... 243.15

T

TAYLOR, valva..... 243.31

TOENNIS, disecador para duramadre..... 243.17

tractor craneal..... 243.6

tractor craneal, CRUTCHFIELD..... 243.5

V

valva, CASPAR..... 243.19, 243.21- 243.28

valva, CLOWARD..... 243.32, 243.33

valva, SCOVILLE..... 243.29, 243.31

valva, TAYLOR..... 243.31

WISE, micro-pinzas de ligadura..... 243.38, 243.39

Y

YASARGIL, galea gancho..... 244.51

YASARGIL, guía-ligadura..... 243.44

YASARGIL, instrumento para microcirugía..... 243.42, 243.43

YASARGIL, pinza..... 243.45

YASARGIL, pinza para agarrar tumores..... 243.35, 243.36

YASARGIL, pinza para aplicar..... 244.75- 244.77

YASARGIL-SAMII, pinza para agarrar tumores..... 243.35

Z

zapato para la fijación, LEYLA..... 243.8, 243.9